

Entrada Beam Slide Handle

Technical Specifications



Product Details

Dimensions (mm)

900, 1200 L x 25 Dia Body x 16 Ends

Material

Solid Brass

Finishes

Aged Brass
Blackened Brass

All finishes are sealed with a clear satin lacquer unless specified otherwise.

Mounting Hardware Included

Yes

Screw / Bolt Type

M6

Mounts From

Back

Dimensions Guide

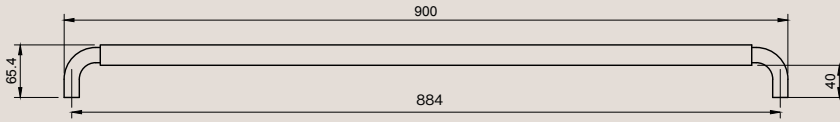

Handle Length: 900mm
Handle Body Width: 25mm
Handle End Width: 16mm

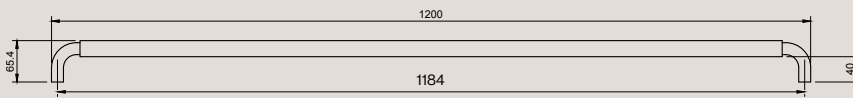

Handle Length: 1200mm
Handle Body Width: 25mm
Handle End Width: 16mm

Blind Hole Mounted Guide

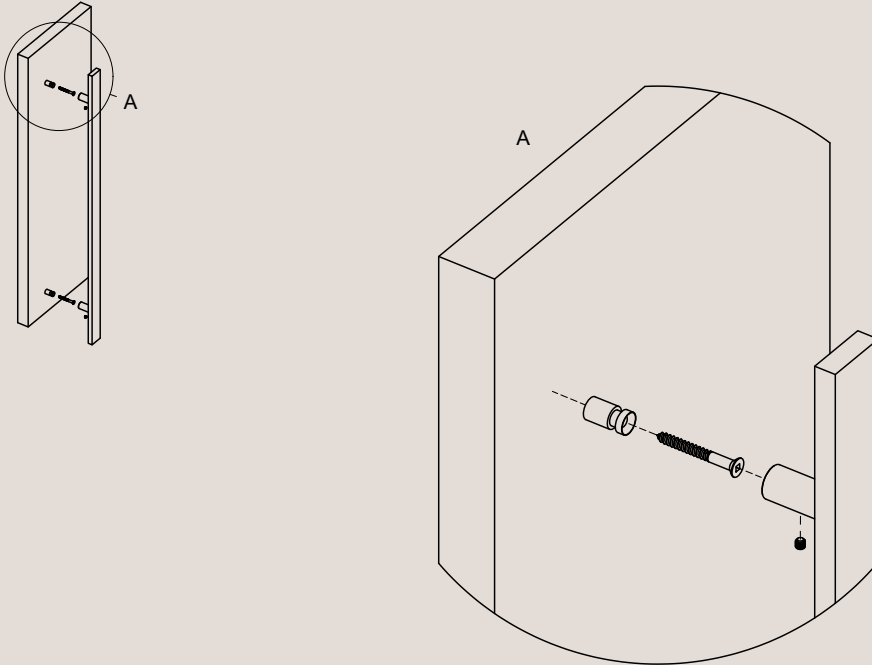

Back To Back Mounted Guide

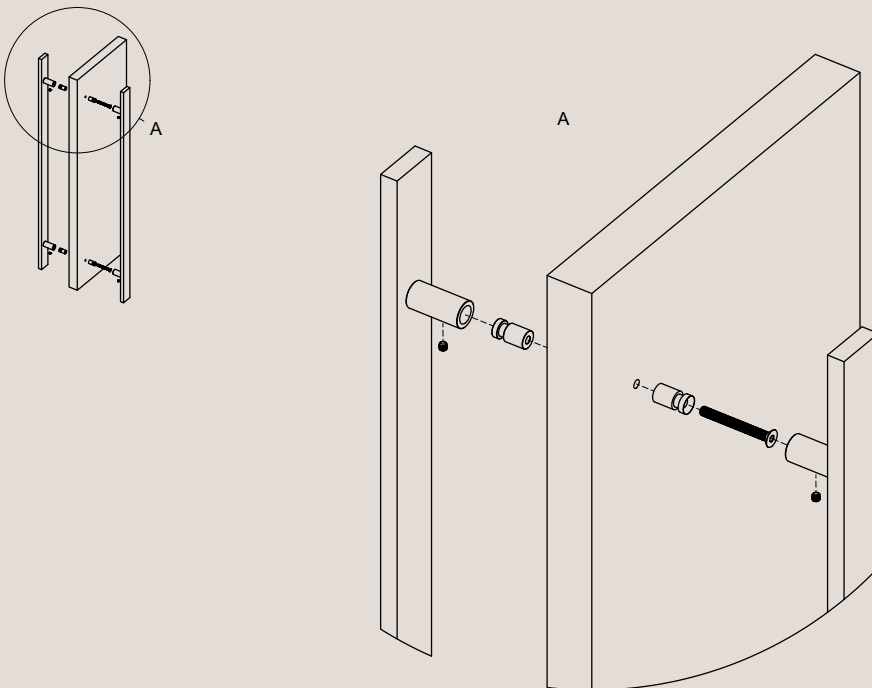

Entrada Beam Slide Handle

Technical Specifications

Product Care

- Regular gentle care and maintenance will preserve and extend the life of your product.
- We suggest cleaning weekly, remove dust with a dry soft microfibre cloth, a damp microfibre cloth may be also be used for tougher areas.
- We recommend only using water. Avoid using cleaning products, oils, and other polishes as they may cause permanent damage.
- We recommend wearing gloves when installing and cleaning your products.
- Do not leave moisture, cleaning products, or solutions on the surface of our products as they may erode the lacquer.